



An analysis of pre-fatigued TIG-treated welded structures

Downloaded from: <https://research.chalmers.se>, 2021-03-12 09:24 UTC

Citation for the original published paper (version of record):

Manai, A. (2021)

An analysis of pre-fatigued TIG-treated welded structures

Engineering Failure Analysis, 121

<http://dx.doi.org/10.1016/j.engfailanal.2020.105150>

N.B. When citing this work, cite the original published paper.



ELSEVIER

Contents lists available at ScienceDirect

Engineering Failure Analysis

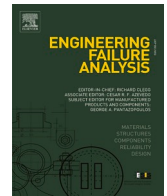
journal homepage: www.elsevier.com/locate/engfailanal

An analysis of pre-fatigued TIG-treated welded structures

Asma Manai

Chalmers University of Technology, Department of Architect and Civil Engineering, 41296 Gothenburg, Sweden

ARTICLE INFO

Keywords:

Extended fatigue life
Steel structures
TIG dressing
Pre-fatigued

ABSTRACT

Many existing steel bridges are approaching, or they have already exceeded their design fatigue life. Assessing and repairing these structures presents a challenge for the construction industry. In this paper, previous studies, which emphasised treating existing (pre-fatigued) structures by TIG dressing, are reviewed and analysed. In total, 109 fatigue test results have been studied which employ various steel qualities, welded details (longitudinal, transverse, and cover plate) and plate thicknesses. A plot and investigation of the S-N curves were carried out. In addition, a sensitivity analysis of the treated crack depth and the TIG dressing penetration depth was used to establish the extended fatigue life. The performance of TIG dressing in treating existing structures was examined by simulating a gain factor. It was found that the extension in fatigue life reached 3.4 times the as-welded fatigue life. This was particularly in cases in which TIG dressing completely removed the initial cracks or missed cracks less than 1 mm deep. Based on the findings, recommendations on treating existing welded steel structures by TIG dressing have been made.

1. Introduction

Many existing structures are ageing. A high percentage of these structures are approaching or have exceeded their design fatigue life. For example, the total number of collapsed bridges between 1970 and 1990 was 10. According to [1], this number further increased to 20 collapsed bridges between 1990 and 2010. In [2], Imam *et al.* collected and reviewed literature studies of metallic bridges to investigate bridge failure (the number of collapsed bridges over the years, the causes, the risks, etc.). In their study, the authors distinguished between bridges that have collapsed and those that have lost serviceability (not yet collapsed). They claimed that for bridges that have lost serviceability, fatigue failure was found to be the most predominant cause (See Fig. 1). Fig. 2 presents the statistics of fatigue failure causes. It is clear that welding was responsible for losing the serviceability of metallic bridges. Therefore, thorough and precise control of the post-weld treatment method used to extend the fatigue life of existing welded steel structures is essential. Manai [3] developed a detailed framework for assessing and repairing existing welded steel structures. In this framework, it was found that the treated crack size (that is introduced in the pre-fatigue phase) and the TIG penetration depth are the most dominant parameters that affect the extended fatigue life. Aeran *et al.* [4] developed a clear methodology to extend the life of the treated offshore structures. In their study, they took both corrosion and fatigue into account during the assessment phase. However, they did not provide any suitable treatment for repairing these structures (offshore). Chaminda *et al.* [5] provided different approaches for making accurate predictions of ageing steel bridges' remaining fatigue life.

Welding is a joining process introduced for the purpose to replace bolting and riveting. Weld is associated with intensive heating and cooling, leading to weld effects at the weld toe which are namely residual stress, micro-defects, high-stress concentration and local change in the material [6]. These effects are detrimental to the fatigue life. Radaj [7] showed that the residual stress and the

E-mail address: Asma.manai@chalmers.se.

<https://doi.org/10.1016/j.engfailanal.2020.105150>

Received 19 September 2020; Received in revised form 27 November 2020; Accepted 27 November 2020

Available online 8 December 2020

1350-6307/© 2020 The Author(s). Published by Elsevier Ltd. This is an open access article under the CC BY license

(<http://creativecommons.org/licenses/by/4.0/>).

geometrical change at the weld toe are the most critical parameters. In order to reduce the negative impact of these effects on fatigue life, many studies focused on studying post-welding treatment on new as-welded structures. The most successful and used post-weld treatment methods are peening, grinding, and TIG dressing.

Peening the weld toe region of steel weldments means that this area is bombarded by hard small, high-velocity shots leading to the expansion of a thin layer at the surface and smoothing the weld toe radius (resulting reduction of the stress concentration) [8,9,10]. Being constrained by the core such inhomogeneous plastic deformation creates compressive residual stresses in the surface zone. Depending on the material and microstructure, the plastic deformation may alter the work hardening state of the surface zone and increase its flow stress [11,12,13]. All compressive residual stresses, surface work hardening, and radius smoothing can have a positive influence on fatigue life. It has been shown that peening can postpone crack initiation [14] and decrease the crack propagation rate [15].

Grinding refers to material removal by individual grains whose cutting edge is bounded by force and path. Weld toe grinding is a well-established technique for improving the fatigue strength of welded joints [16,17,18]. The main aims of the operation are to reduce the local stress concentration and to remove crack-like flaws at the weld toe. To obtain significant improvement in fatigue life, it is recommended to grind to at least 0.5 mm below any visible undercut to ensure that the intrusions and crack-like flaws are removed [19]. Such treatment justifies an increase in fatigue design endurance of at least 2.2 times according to [20]. Since all flaws are expected to have been removed after grinding, the proportion of the fatigue endurance spent initiating a crack is expected to be significant.

TIG dressing is an arc welding process in which the heat is produced between a non-consumable electrode and the work metal. The heat of the arc produced melts the base metal. TIG dressing removes the weld toe defects by re-melting the material at the weld toe, reduce the local stress concentration by increasing the weld toe radius providing a smooth transition between the plate and the weld face [21,22,23], and reduce the magnitude of residual stress [24,25,26,38,39,40]. It was found in [27] that TIG dressing could introduce in some cases compressive residual stress. These effects increase the fatigue life. This increase in fatigue life is primarily the result of extending the crack initiation life and leads to an increase in the fatigue design endurance of 3.4 times according to [28].

These studies emphasize studying post-weld treatment applied to new welded details. However, many existing welded structures have accumulated damage and showed cracks. Replacing all these structures at the same time represents a challenge for the construction industry. Therefore, the treatment of these structures represents an attractive solution. Thus, there is a need to study the application of post-weld treatments and their effects on existing welded structures. TIG dressing is one of the most widely utilised post-weld treatments used by the industry. TIG dressing produces more effective benefits than grinding [20]. However, the efficiency of this treatment is lower than the efficiency of peening [8,9]. TIG dressing is presented using three parameters: geometry (radius at the weld toe), residual stress [26], and depth of treatment penetration [25,27]. Throughout the literature merely only four studies have focused on studying the efficiency of TIG dressing on treating existing weld steel structures.

Ramvalho et al. [29] investigated the effect of TIG dressing on cracked T-joint details and showed that TIG dressing extends the fatigue life by a factor of 2.5 when the crack is completely removed. The authors concluded that no significant improvement in fatigue life occurs when TIG does not completely remove the crack. In Fisher et al. [30], three improvement techniques were studied experimentally and observed to be effective to varying degrees in extending the fatigue life of welded details. Grinding was not as effective as peening and TIG dressing. Peening was observed to produce good results with both uncracked as-welded details and pre-fatigued specimens containing cracks less than 3 mm deep. A TIG treatment of the cover plate with a crack depth that varied between

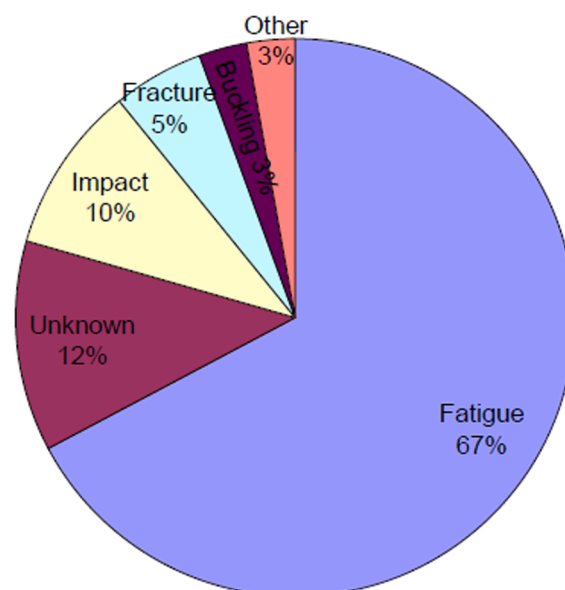

Fig.1. Failure cause for metallic bridges losing their serviceability.[2]

1.5 mm and 7 mm (at the weld toe) was investigated. These authors concluded that TIG dressing completely removes the cracks from the weld toe but causes a failure in the root in some cases. Thus, the other conclusion that TIG dressing was the most effective method examined in the laboratory and was also effective in repairing pre-fatigue details with surface cracks less than 5 mm deep. Miki et al. [31] investigated pre-fatigued longitudinal and transversal attachments and showed that the efficiency of TIG dressing is dependent on two factors: the depth of the crack to be treated and the depth of TIG penetration. In [29,30] and [31] the authors present extensive test results of repairing pre-fatigued steel structures by TIG dressing. A summary of these studies was performed by Manai in [32]. Alkarawi et al. [33] investigated a cracked transversal attachment manufactured with steel S355. They showed that TIG dressing induces two major effects which are namely compressive residual stress at the weld toe and succeed to completely remove 1 mm deep cracks. Both effects resulted in an extension in the fatigue life more than 3.4 times the as-welded fatigue life.

In the recommendations from the International Institute of Welding (IIW), the improvement of as-welded steel structures using TIG dressing was presented. IIW reported an increase in fatigue life by a factor of 3.4 without any betterment in the slope of the S-N curve [28]. However, [28] are limited to newly as-welded structures and lack indications of its applicability to pre-fatigued as-welded structures.

In [29,30,31] and [33] the authors have tested a large test of series of different weld details, different steel qualities, and different load levels, but a deep conclusion and a sensitivity analysis of the different parameters that affect the TIG dressing efficiency was not established. For that reason, in this study, an individual screen, analysis and discussion of each of the collected test series was performed. A sensitivity analysis of the depth of treated crack and the TIG penetration depth on the fatigue life extension was established. In bridge design [34,35] the engineer uses Eurocode and IIW. For this reason, a recommendation of the extension in the fatigue life of welded steel structures based on the used engineering codes is very essential. Based on all the tested together a recommendation on treating pre-fatigued steel structures by TIG dressing using engineering codes was established.

2. Analysis of the collected data

Many researchers studied in the deep post-weld treatment of new as-welded details. Whereas, there are existing structures that need treatment in order to not consider them as structures lost their serviceability and extend their fatigue life. Some researchers addressed this problem by studying the effects of different TIG dressing on the extension on the fatigue life. Table 1 summarizes the information about these studies. A deep screen of all the test series was investigated in the following sections.

In Table 1, UT is ultrasonic, SG is strain gauges, R is the stress ratio

2.1. Analysis and discussion of Miki et al.

Miki et al. [31] investigated the effect of TIG dressing on repairing pre-fatigued fillet-welded joints, which were transversal and longitudinal attachments. Fig. 3 and Fig. 4 present the dimensions and configuration of the specimens. The material for the main plates was steel SM58, and the material for the attachment plates was steel SM50. Table 2 lists the mechanical properties of these materials. Fatigue tests were performed by four-points bending (refer to Fig. 3 and Fig. 4).

In total 40 as-welded specimens (20 longitudinal attachments and 20 transversal attachments) were pre-fatigued as follows. The transversal attachments were loaded with stress range 280 MPa up to 450 000 cycles to produce fatigue cracks. Meanwhile, the longitudinal attachments were loaded also with stress range 280 MPa, but with a number of cycles from 300,000 to 350,000 cycles. After this loading stage, for both test series, non-destructive tests (dye penetrant and ultrasonic tests) were used to detect the

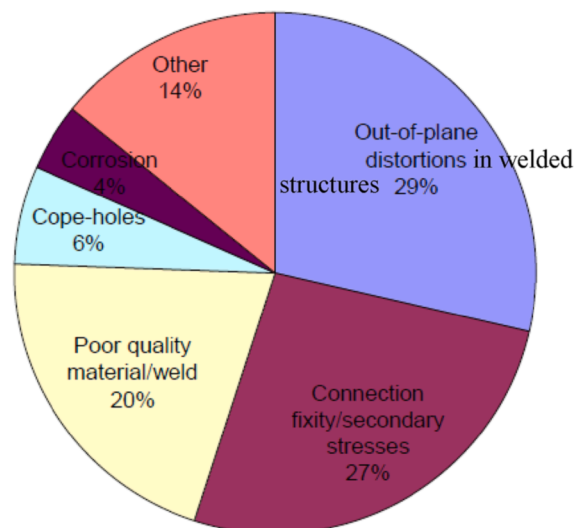

Fig. 2. Reasons for bridges' fatigue cracks that have lost their serviceability (not yet collapsed). [2]

Table 1
Collected pre-fatigue tests treated by TIG dressing.

Reference	R	crack measured before testament	Plate thickness	Crack detection method	Weld detail	FAT	Loading
[29]	0.05	Yes	12.5	SG	Transversal	100	Pending
[30]	0.15	Yes	14	UT	Cover plate	50	Tension
[30]	0.15	Yes	14	UT	Cover plate	50	Tension
[30]	0.15	Yes	14	UT	Cover plate	50	Tension
[31]	0.1	Yes	15	Dye penetrant and UT	Transversal	100	Pending
[31]	0.1	yes	15	Dye penetrant and UT	Longitudinal	71	Pending
[33]	0.3	yes	16	UT and SG	Transversal attachment	100	Tension

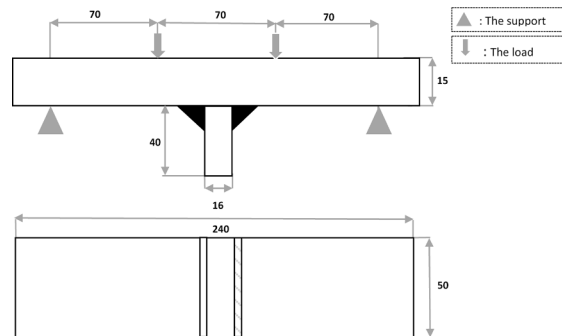

Fig. 3. Dimensions of the transversal attachment in mm.

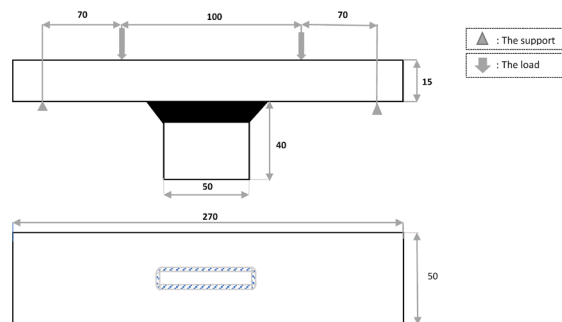

Fig. 4. Dimensions of the longitudinal attachment in mm.

Table 2
Mechanical properties of SM58 and SM50.

Material	Mechanical proprieties	
	Yield strength [MPa]	Tensile strength [MPa]
SM58	590	680
SM50	410	560

dimensions and shapes of any probably induced cracks. Two cases were found. The first case is that in some pre-fatigued specimens no cracks were detected. The second case is that cracks with depths from 2 to 6 mm were detected at the weld toe for other specimens. The pre-fatigued welded joints were repaired by TIG dressing. The average value of the weld toe radius after TIG treatment was measured to be 5 mm. The fusion depth of TIG ranged from 3 to 4 mm. It was found that in some specimens, TIG succeeds to completely re-melted the initial cracks and in other specimens, there are remaining subsurface cracks.

Fig 0.5 and Fig. 6 show the experimental data points and their corresponding mean curves of new as-welded specimens and pre-fatigued treated specimens where cracks were completely re-melted for transversal attachment and longitudinal attachment, respectively. The test results are fitted using Eq.1.

$$\Delta\sigma = CN^m \quad (1)$$

Where C and m are constant parameters. The as-welded characteristic S-N curve, the as-welded mean S-N curve and the characteristic TIG dressing S-N curve for the transversal and longitudinal attachment are represented by Fig. 5 and Fig. 6, respectively [26].

An S-N curve was derived from the experimental new as-welded tests using IIW recommendation, by multiplying the fatigue life of the experimental new as-welded life by a factor of 3.4. The newly derived S-N curve is plotted for both the longitudinal and transversal attachments and is considered as a new as-welded TIG dressed S-N curve.

Analyzing and drawing inference from Fig. 5 and Fig. 6 the following conclusions could be extracted:

- (1) In the case where TIG dressing completely removed the initial cracks:
 - Regardless of the weld details, the experimental extended fatigue lives are higher than those of the as-welded (experimentally and from the design curve, IIW).
 - Regardless of the weld details, the improvement in the fatigue life of pre-fatigued TIG dressed specimens are higher than those of new as-welded TIG dressed (i.e. higher than 3.4 times the as-welded fatigue life). The improvement in fatigue life is found to be 7.5 times the as-welded fatigue life for longitudinal attachment. While the improvement in fatigue life is at least 4.5 times the improvement in the as-welded fatigue life for transversal attachment.
 - For longitudinal attachment, the experimental as-welded S-N curve and the experimental TIG dressed S-N curve has the same slope. Meanwhile, for transversal attachment, there is an increase in the slope of TIG dressed S-N curve compared to the slope of the as-welded S-N.
- (2) In the case where TIG dressing does not completely remove the initial cracks:
 - Regardless of the welded details, when the remaining cracks are deeper than 1.3 mm, the extended fatigue life is lower than the as-welded fatigue life.
 - Regardless of the welded details, when the structure contains remaining subsurface cracks, the extended fatigue life is found to be lower than the as-welded fatigue life.

The highest improvement in fatigue life is detected in the case where TIG succeeded in completely removing the cracks. Therefore, the extended fatigue life is found to be above the new as-welded TIG dressed one. Thus, the extended fatigue life includes the crack initiation period of the treated structure. In addition, it was found that in this case (in the case where TIG completely demolishes the initial crack) the extended fatigue life is independent of the initial crack size. For example, in Fig. 7, for the stress range of 274 MPa, the extended fatigue life for cracks between 0.75 mm and 3.75 mm is a scatter of points between 3 million and 4.8 million cycles. While in the case where there are subsurface remaining cracks, the extended fatigue life is strongly dependent on the remaining crack size. Fig. 8 shows the extended fatigue life as a function of the remaining subsurface crack for transversal and longitudinal attachment. The extended fatigue life decreases when the remaining crack increase and that include the crack propagation phase. Note that all specimens failed at the welded toe, which concludes that the fatigue life is strongly influenced by the state of the weld toe after treatment.

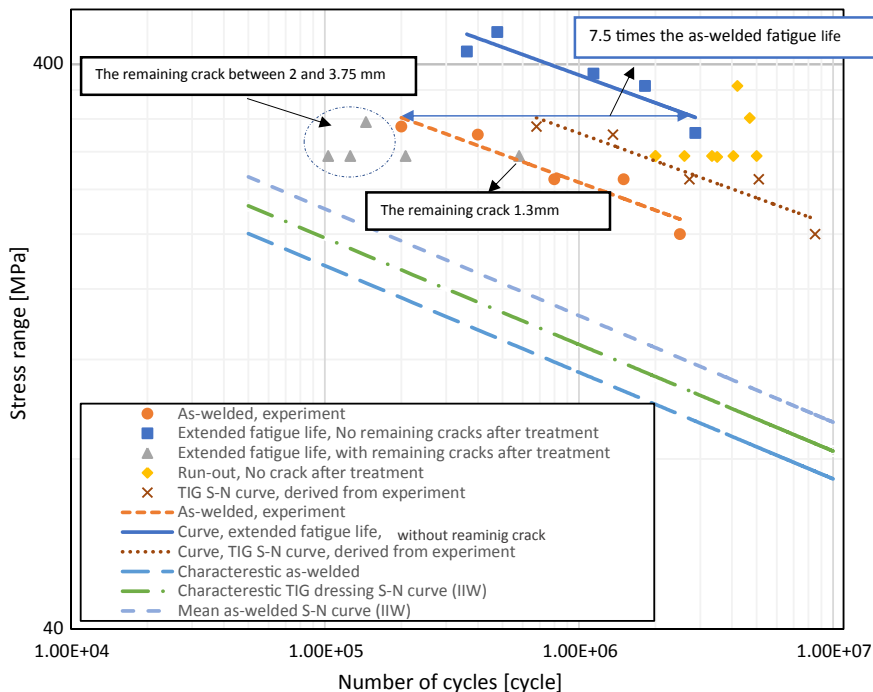

Fig. 5. S-N curve of longitudinal attachment.

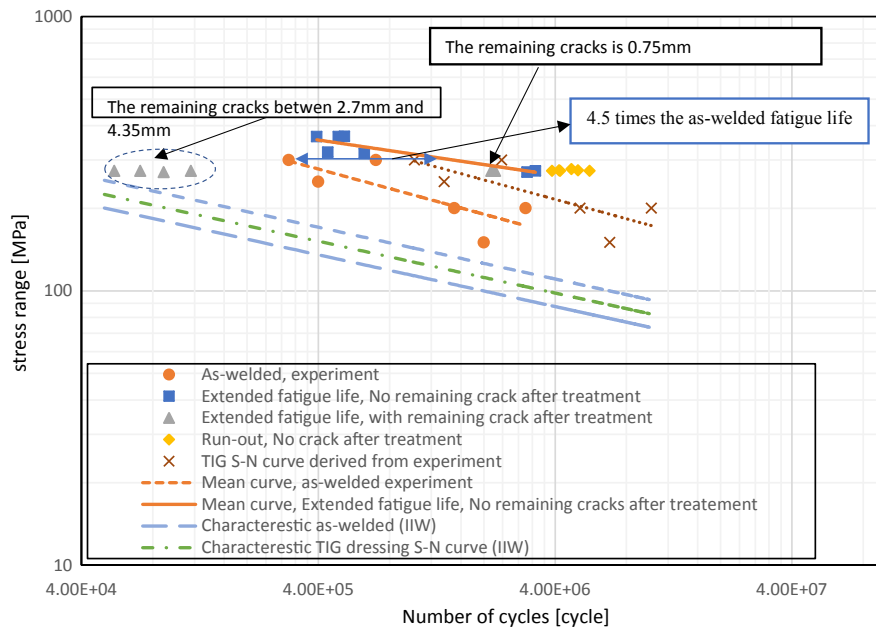

Fig. 6. S-N curve of transversal attachment.

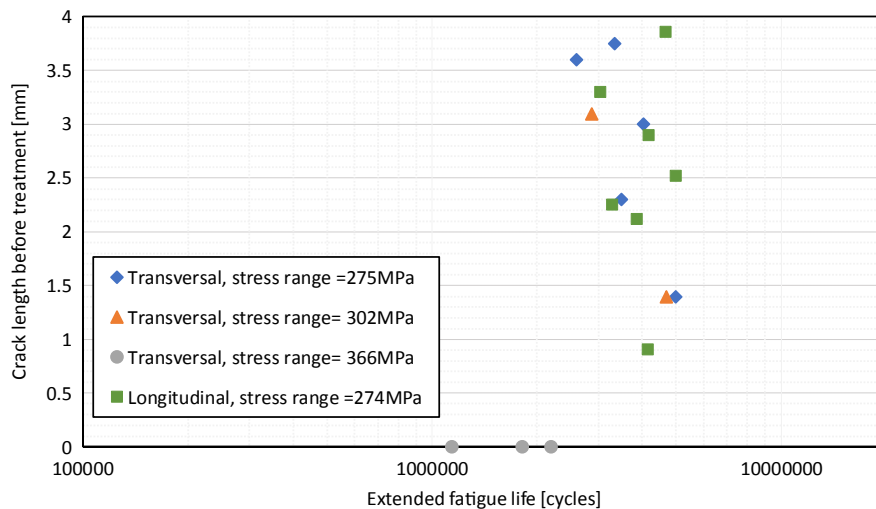

Fig. 7. Crack length before treatment as a function of the extended fatigue life.

2.2. Analysis and discussion of Ramalho et al.

Ramalho et al. [29], studied pre-fatigued specimens treated by TIG dressing. The tested specimens consist of transversal attachment manufactured with medium-strength steel St-3DIN 17,100 with a yield strength of 384 MPa and ultimate stress of 555 MPa. Fig. 9 shows the geometry and dimensions of the specimens.

To obtain the pre-fatigue state, the as-welded specimens are submitted to bending loading (refer to Fig. 9) with a stress ratio $R = 0$ until register an increase of 10% in the initial deformation at the weld toe. It was found that this increase in the deformation corresponds to 99% of the characteristic as-welded fatigue life. Also, the recorded increase in deformation is caused by the initiation and propagation of fatigue cracks with a maximum depth of 3 mm. All pre-fatigued specimens contained cracks. After the specimens were treated by TIG dressing using the parameters in Table 3, two cases were obtained. In the first case, TIG treatment completely removed the crack; in the second case, subsurface cracks remain in the structure.

A statistical analysis of the radius at the weld toe, after TIG dressing, shows an average value of 6.25 mm with a standard deviation of 1.99. The average value of the radius is used to compute the stress concentration factor. This factor showed a decrease from 1.76 (in

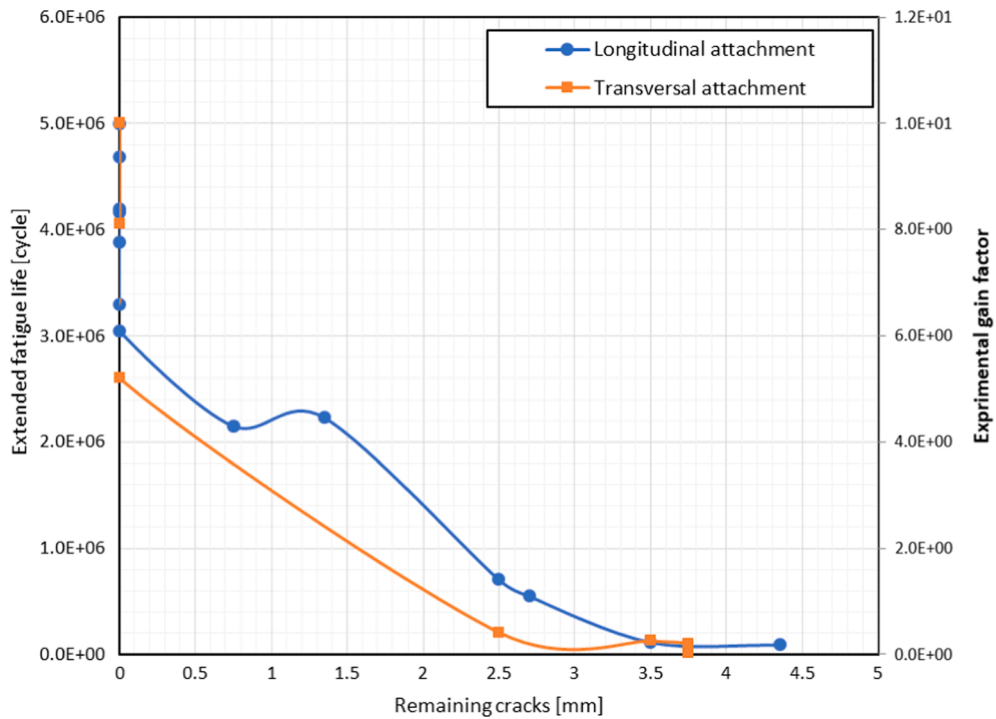

Fig. 8. Extended fatigue life and experimental gain factor as a function of the remaining cracks.

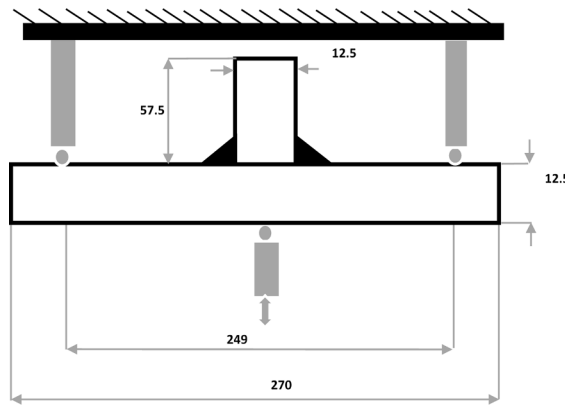

Fig. 9. Geometry of the tested specimen.

Table 3
TIG dressing parameters.

TIG dressing parameters
Argon flux
Current intensity –110 A
Tension DC –19 V
Linear rate –1.08 mm/s

the as-welded state) to 1.4 (after TIG dressing treatment) due to radius smoothing. [29] established that the fatigue strength at the weld toe is strongly affected by the induced TIG residual stress. In these tests, two different techniques were used to measure residual stress at the weld toe which is X-ray diffraction and the hole drilling method. The conducted measurements for a randomly selected specimen showed that TIG dressing introduced a –80 MPa (compressive) residual stress at the weld toe. The depth of a_{TIG} is used to determine whether the treatment completely removes the crack when $a_0 < a_{TIG}$ or whether a subsurface crack remains when $a_0 > a_{TIG}$. A

statistical analysis of a_{TIG} showed an average value of 3.5 mm. In these tests, for most of the treated specimens, cracks remain after treatment, which caused a lower extended fatigue life (less than $1E6$ cycles).

Within this study, all tested specimens showed subsurface with remaining cracks post-treated. This observation can be used to draw the following preliminary conclusions (See Fig. 10):

- (1) The pre-fatigue specimens with up to 99% of the characteristic as-welded life showed cracks deeper than 3 mm.
- (2) The extended fatigue life of specimens, pre-fatigued up to 99% of their as-welded characteristic life, is lower than the as-welded fatigue life. It is 0.77 as-welded fatigue life.
- (3) The TIG dressing treatment is not effective for treating deep cracks, namely, cracks deeper than the fusion depth (a_{TIG}).

2.3. Analysis and discussion of Fisher et al.

Fisher et al. [30] studied steel cover-plated specimens in either as-welded or pre-fatigued condition, to determine the fatigue strength of these details when treated by techniques intended to extend their fatigue life. In this study, an emphasis on TIG dressing treatment was performed. The mechanical proprieties of the used material to manufacture these specimens are listed in Table 4.

A series of preliminary tests were conducted to find the effect of welding variables TIG penetration depth. The results of this study indicate that maximum penetration is obtained by the use of helium shielding gas and a cathode vertex angle between 30 and 60 degrees. These parameters, which are listed in table 5, were used in the performed tests. The TIG penetration depth was 4.3 mm.

Where CVA is a cathode vertex angle.

In total 50 tests were performed which are divided into three-test series. The first test series consist of as-welded specimens treated prior to any fatigue testing. The second test series consist of as-welded specimens that were first pre-loaded up to 75% of the lower confidence limit of as-welded-untreated detail. Then, these specimens were TIG treated. The third test series consist of as-welded test pre-loaded until introducing visible cracks then TIG treated. For the second and the third test series, cracks as large as 19 mm length and between 1.3 mm and 5 mm deep were observed prior to TIG treat. After TIG treat the initial cracks of the pre-fatigued specimens', in a few cases, the cracks were not completely removed.

The results of all three-test series are summarized in Fig. 11. The same figure also shows the characteristic as-welded and TIG dressed S-N of the corresponding detail. The test points plotted as 'new as-welded the TIG treated' present specimens treated prior to applying cyclic loading. The test points identified as 'pre-fatigued until 75% of the characteristic life' were all pre-loaded to 75% of the characteristic S-N curve of untreated details then TIG treated. Those points indicated as 'pre-fatigued until visible crack' present as-welded specimens pre-loaded until the introduction of clearly visible cracks and then TIG treated.

Improvements in the condition at the weld toe could not affect the growth of cracks from the weld root. Most of the details treated by TIG dressing had their life governed by failure from the weld root. The weld toe has been re-melted to smooth the radius transition and remove the initial cracks.

Therefore, the stress concentration and the initial discontinuity conditions are reduced at the weld toe which forced root failure and

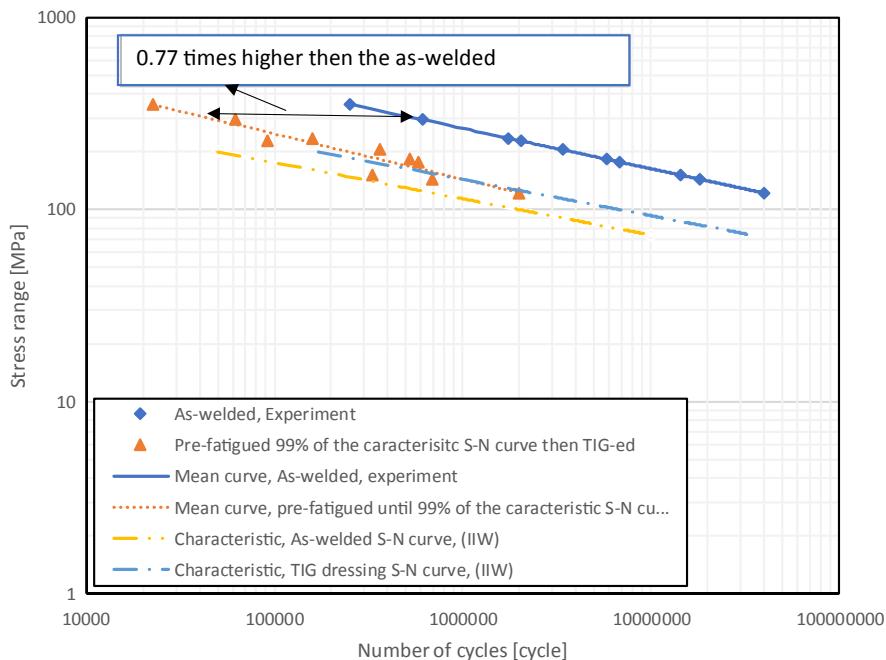

Fig.10. S-N of transversal attachment, extended fatigue life as a function stress range.

Table 4
Mechanical proprieties of the used material (A36).

Steel	Yield strength (MPa)	Mean elongation (%)	Mean redaction in the area (%)
A36 steel	275.6	30.3	50.4

Table 5
TIG dressing parameters.

CVA (degrees)	Current (amps)	Voltage (volts)	Heat input (kilojoules/in.)	Penetration (mm)
60	200	16	64	4.3

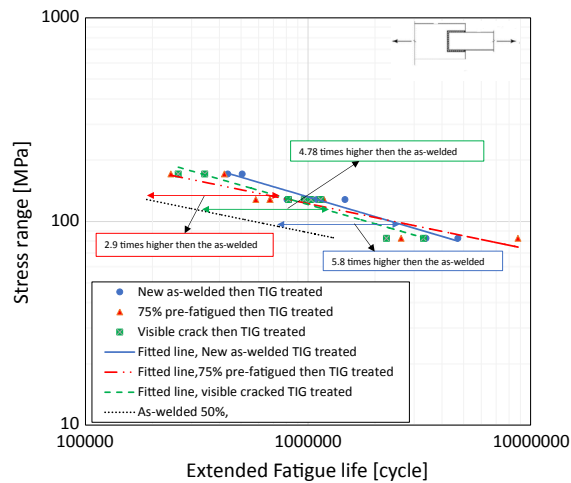

Fig. 11. S-N curve of the cover plate, stress range as a function of the extended fatigue life.

resulted in greater life.

This study has shown that TIG dressing can be reliably used to either improve or upgrade (repair) the fatigue strength of welded details that experience cracks growth from weld toes when applied to as-welded details or to details that have experienced cyclic loading and have cracks less than 5 mm deep.

The fatigue strength can be expected to increase at least 3.4 times the as-welded fatigue life and it cannot exceed 5.8 times the as-welded fatigue life. Higher improvements are not possible because crack growth from the weld root cannot be prevented. Therefore, the application of TIG can effectively strengthen the detail and provide substantial increases in life. Cracks with depths that exceed the penetration capability of TIG dressing cannot be repaired by this procedure.

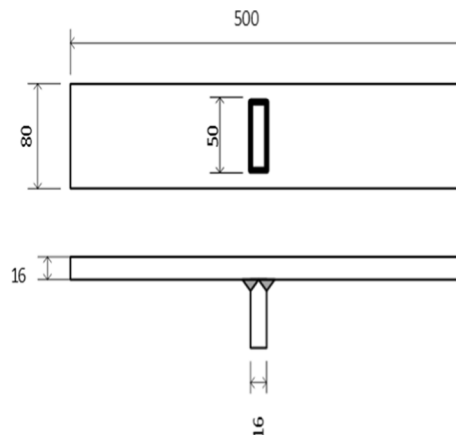

Fig. 12. Dimension and shape of the specimen in mm.

2.4. Screening and analysis of Al Karawi et al.

Al Karawi et al. [33] studied prefatigued welded transversal attachment treated by TIG dressing. Fig. 12 shows the dimension and shape of the specimen. The specimens were manufactured with carbon mild steel S355, and the filler material was made of core-weld C6LF (metal-cored wire). The mechanical properties of the used materials as well as the weld parameters are listed in table 6 and table 7, respectively. In total, 21 test results were presented divided into two test series. The first test series composed of 18 as-welded specimens. The second test series composed of pre-fatigued as-welded specimens then TIG treated. All tests are subjected to constant amplitude axial fatigue tests with a stress ratio of 0.29. 3D laser geometry scanning was used to investigate the weld toe radius and TIG penetration depth. The examined average radius at the weld toe was found to be 5.1 mm and the average TIG penetration depth was 2.1 mm. A measurement of TIG residual stress distribution at the weld toe after TIG dressing was performed and showed that TIG dressing in this case induced compressive residual stress at the weld toe. The benefit of TIG re-melting is mainly attributed to the geometry improvement [23]. However, the treatment might also change the status of residual stresses at the weld toe. In their study [23], the authors used the strain drop method as a crack detection methodology. It was found that a 25% drop in any of SGs reading corresponds to a crack smaller than 1 mm. To obtain the second test series, the specimens were preloaded until registering a drop in the strain up to 25%. Then TIG dressing was performed to treat these specimens and continuation of fatigue testing was followed.

3. Gain factor

Gain factor in fatigue life is needed to quantify the efficiency of TIG dressing in treating pre-fatigue welded details. According to IIW [26] for a treated new as-welded specimen, the gain in fatigue life is defined as the ratio of the fatigue life of TIG treated specimens to the corresponding as-welded fatigue life for a given stress range. Moreover, it has been noted in IIW that there is no improvement in the slope of the S-N curve of the new as-welded TIG treated specimens (as-welded then directly TIG treated, i.e. no prefatigued phase before TIG treatment) compared to the slope of the corresponding as-welded specimen. Therefore, the gain factor in the fatigue life is independent of the stress range and it is constant to be 3.4. Fig. 13 shows a schematic presentation of the gain factor, where the blue line is the as-welded S-N curve and the grey line is the new as-welded TIG treated S-N curve.

To study the efficiency of TIG dressing in treating pre-fatigue welded details, the definition of gain factor presented earlier in accordance with IIW guidelines is utilized. The gain factor is the

the ratio of the fatigue life after TIG treatment to the as-welded fatigue life ($GF = \frac{N_{TIG}}{N_{AW}}$). For treating existing structure, N_{TIG} represent the fatigue life of the structures after TIG treatment. Therefore, in this case (treating existing structures) the N_{TIG} will be replaced by the N_{ext} (which the extended fatigue life after TIG treatment). Concerning the N_{AW} , it always presents the fatigue life of the structure in its as-welded state.

3.1. Experimental gain factor

For all the collected and analyzed data [29,30,31] and [33], the experimental as-welded S-N curves and the S-N curves of the treated pre-fatigued structures have been investigated. To study the efficiency of TIG dressing in extending the fatigue life, a factor relating the experimental as-welded fatigue life (no treatment was performed) and the experimental extended fatigue life was established to simulate the experimental gain in fatigue life.

$$GF_{exp} = \frac{N_{ext}}{N_{aw,exp}}$$

Where

- N_{ext} is the experimental extended fatigue life,
- $N_{aw,exp}$ is the experimental as-welded fatigue life at the same stress range.

For investigating all the collected data, a plot of the points for each dataset is made to correlate with the defined gain factor as a function of the remaining cracks after treatment (See Fig. 14). The justification of the reason to plot the gain factor as a function of the remaining crack and not as the pre-fatigued life (N_{pre}), can be that the remaining cracks include the treatment penetration depth (treatment efficiency) and the initially introduced crack (the pre-fatigued life). This implies that the induced crack on the specimen with a verified depth is a result of exposure to a predefined cyclic stress range and thus, the plotted points are independent of the stress range and the stress ratio. it can be seen that in the case of cover plate [Fisher], there are cases where the total cracks were removed but the gain factor of these specimens was lower than 3.4. for these specimen root cracks were detected.

Table 6
Welded parameters.

Run	Diameter of electrode [mm]	Weld current [A]	Welding voltage [V]	Welding speed [Mm/sec]	Wire feed speed [Mm/min]	Heat input [KJ/mm]
1	1.2	240	28.3	140	9.2	0.9
2	1.2	230–240	28.3	130–140	9.2	0.9–1

Table 7
Mechanical proprieties of the used materials.

	Yield strength [MPa]	Ultimate strength [MPa]	Elongation %
S355	355	575	22
C6LF	459	557	31

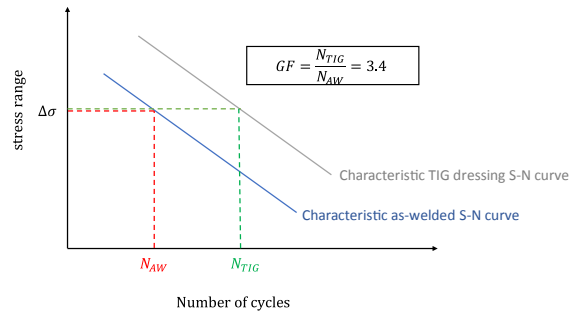

Fig 13. Schematic presentation of the gain factor.

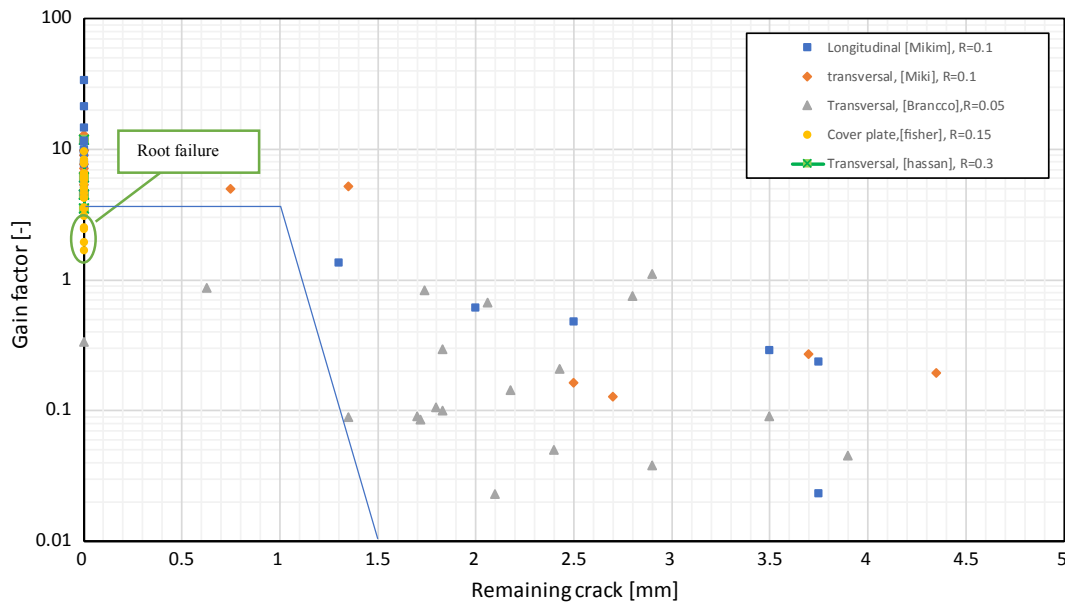

Fig. 14. Experimental gain factor as a function of the remaining cracks.

3.2. Design gain factor

During the design phase of the structures, the engineers do not have the experimental as-welded S-N curve of the studied detail, on the other hand, they possess the characteristic S-N curve of the studied detail. Therefore, a determination of a gain factor that relates the extended fatigue life and the characteristic as-welded fatigue life is more relevant for the engineer.

$$GF_{car} = \frac{N_{ext}}{N_{aw,car}} \tag{3}$$

Equation (3) presents the characteristic gain factor, where

- N_{ext} is the experimental extend fatigue life
- $N_{aw,car}$ is the characteristic of as-welded fatigue life at the same stress range.

Independent of stress range, stress ratio and steel qualities, it was found that the characteristic gain factor in fatigue life is more than

3.4 where crack completely removed and also for missing cracks less than 2 mm (See Fig. 15).

4. Sensitivity analysis of gain factors

In Miki et al [31] a large test series were provided which allow to deep analysis them. For the characteristic gain factor for longitudinal attachments, independent of stress range, remaining crack after treatment, it was found that the gain in fatigue life is more than 3.4 where crack completely removed and also for missing cracks less than 1 mm (See Fig. 16). Also, the characteristic and the experimental gain factor was plotted at the same curve. Fig. 17 shows the same results for transversal attachment.

Therefore, it is challenging to be sure if a crack of 1 mm depth was missed in a real structure. Hence, there is a need for a reliable method to detect short subsurface cracks.

5. Crack detection

The extended fatigue life strongly depends on the crack depth. Moreover, it was established that If TIG dressing remains subsurface cracks deeper than 1 mm, the extended fatigue life is strongly dependent on the size of the remaining cracks. Furthermore, it should be noted that more the remaining cracks are deeper less the extension in fatigue life. Therefore, it is required to predict a reliable value of the crack depth for an accurate prediction of fatigue life extension. However, in real structures, a crack measurement can be difficult to achieve. Several non-destructive monitoring techniques are used in the industry to detect fatigue cracks. A brief description of the non-destructive testing (NDT) methods is presented in [36] and [37].

In practice, the engineer has access to the characteristic fatigue life of the structures (from codes), and on the pre-fatigued fatigue life. Therefore, it is convenient to find a relation between these two information and the remaining crack depths after TIG treatment.

Within the collected 109 tests, there is information about the pre-fatigued life, the characteristic fatigue life, and the introduced cracks (during the pre-fatigued life). A plot of the ratio $(\frac{prefatiguedlife}{characteristicfatiguelife})$ as a function on the remaining crack depths after treatments were plotted in Fig. 18. Fig. 18. Shows that for a ratio $(\frac{prefatiguedlife}{characteristicfatiguelife}) < 300$ there are no remaining cracks after treatments. Therefore, it could be concluded from the collected data that, there is not possibility to miss cracks during TIG treatments when the ratio $(\frac{prefatiguedlife}{characteristicfatiguelife})$ of the treated structures is lower than 300.

6. Recommendation

The established analysis from the collected data [29,30,31] and [33] and the framework reported in [3] have indicated that the primary factors influencing the extended fatigue life are the initial crack depth and TIG penetration depth which result in the sub-surface remaining crack depth. It was found from a large test series that the TIG penetration depth is between 2.5 mm and 4 mm.

Based on 109 tests, for different steel quality, stress ratio and plate thickness, the main recommendation to treated pre-fatigue welded structures are listed in the Table 8.

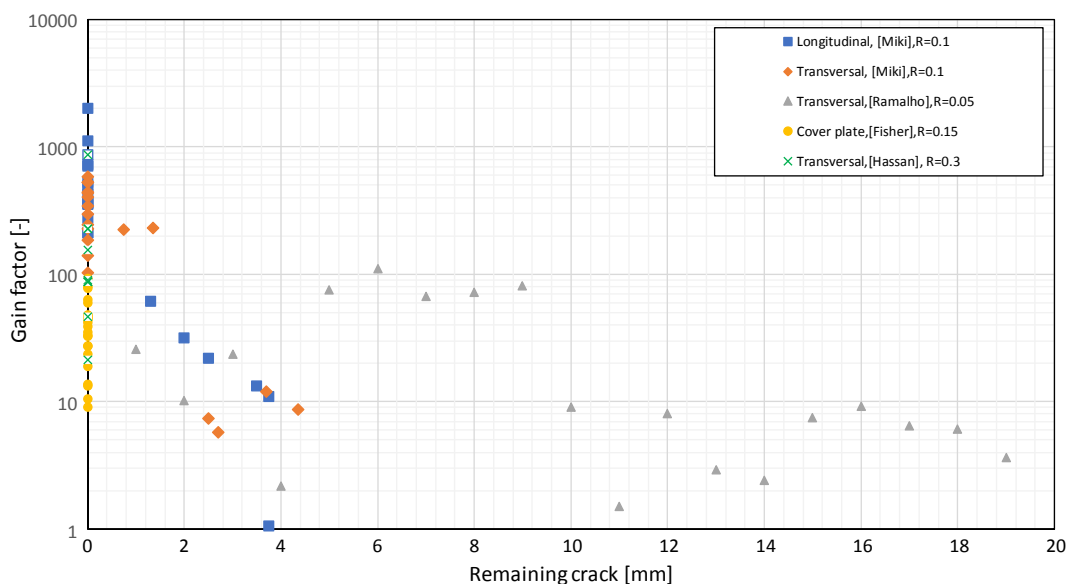

Fig 15. Design gain factor as a function of the remain crack sizes.

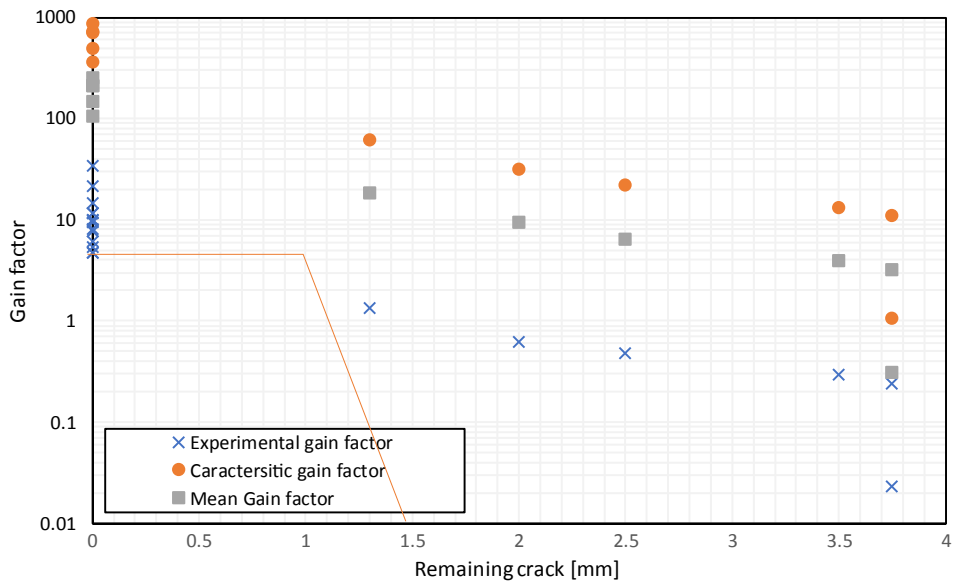

Fig 16. Longitudinal attachment: gain factor as a function of the remaining crack size.

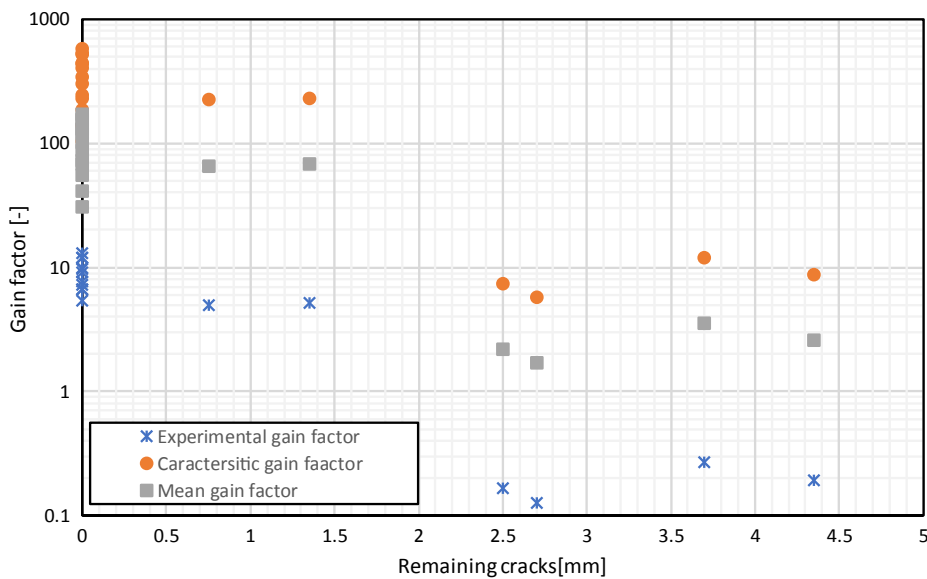

Fig 17. Transversal attachment, gain factor as a function of the remaining crack size.

7. Discussion and conclusion

Many steel structures are approaching or already exceeded their design fatigue life. Replacing all these structures represents a challenging solution for the industry. Therefore, treating the existing structure to continue to be used present meanwhile the construction of the new structures are taking place represent a challenge solution for the industry. TIG dressing represents an attractive solution for the industry. Thus, a literature study of the pre-fatigue test treated by TIG dressing was performed. In total, 109 fatigue tests were compiled.

In light of the preceding study, it was found that the following points hold independent of the weld detail, steel quality, loading type, plate thickness and stress ratio.

- If TIG dressing completely removes the initial cracks (induced in the pre-fatigued phase) the extended fatigue life is at least 3.4 times the as-welded fatigue life. This corresponds to the lower design gain factor and therefore, the specimens after treatment have at least the fatigue life of new as-welded TIG treated specimens.

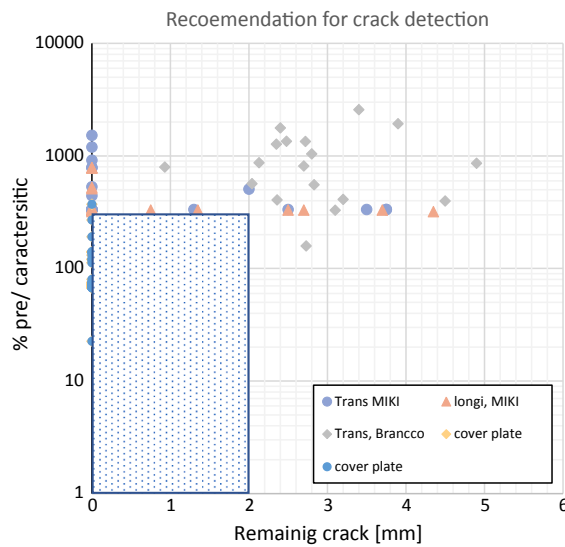

Fig 18. Ratio $(\frac{prefatiguedlife}{characteristicfatiguelife})$ as a function of the remaining fatigue life.

Table 8
Recommendations.

Detail category	Loading	Recommendation			Observation
		If TIG remove completely the initial crack	If TIG remains 1 mm subsurface crack	If TIG remains subsurface cracks deeper than 1 mm	
Longitudinal Transversal Cover plate	Bending Bending Tension	The extended fatigue life is 3.4 times the as-welded fatigue life	The extended fatigue life is 3.4 times the as-welded fatigue life	There is no significant improvement in the fatigue life the extension is at least 10% the as-welded fatigue life	- In the case were the prefatigued structure showed a crack, as the size of the remaining subsurface crack is determinantal for the extended fatigue life, a reliable NDT is needed to measure the remaining cracks.- In the case were the prefatigued structure does not show any cracks, it is more probable that even there is a shallow crack it will be re-melted.- The prefatigued life is indicative of the remaining cracks.

- The extended fatigue life strongly depends on the crack depth. Moreover, it was established that if TIG dressing remains subsurface cracks less than 1 mm, the extended fatigue life is at least 3.4 times the as-welded fatigue life. However, if TIG dressing remains subsurface cracks deeper than 1 mm, the extended fatigue life is strongly dependent on the size of the remaining cracks. Furthermore, it should be noted that more the remaining cracks are deeper less the extension in fatigue life. Therefore, it is required to predict a reliable value of the crack depth for an accurate prediction of fatigue life extension. However, in real structures, crack measurement can be difficult to achieve. Several non-destructive monitoring techniques are used in the industry to detect fatigue cracks. A brief description of the non-destructive testing (NDT) methods is presented in [36] and [37].
- To detect if the subsurface remaining cracks are lower than 1 mm an accurate and reliable non-destructive crack detection is needed. A miss measurement of the remaining cracks will strongly affect the predicted extended fatigue life. Therefore, it is very sensitive to measure the remaining cracks. In real bridge, it is very challenging to detect if there is a crack or not and even more, challenging aspect is to measure the remaining subsurface cracks after treatment. Two recommended method to predict the remaining subsurface cracks are as follows:
 - If the initial crack size is known, according to [29,31,33] the lower TIG penetration depth is between 2.5 and 4 mm. To be on the safe side, a lower choice of TIG penetration on the specimen. Therefore, the remaining crack depth is equal to the initial crack depth reduced by 2.5 mm.
 - If the size of the initial crack is not known, the pre-fatigued fatigue life will be used to determine the percentage of the consumed life [3]
- A limited type of welded joints, namely, longitudinal, transversal attachments and cover plate (pre-fatigued and then TIG treated), were explored in this study. Thus, the significance of the established recommendations should be further highlighted for other **welded joints** and real ageing existing structures using more case studies with **different types of steel**. Thereafter, the proposed recommendation may be adopted and implemented in the assessment standards in the future.

8. Conflict

Many existing structures are ageing. A high percentage of these structures are approaching or have exceeded their design fatigue life. For example, the total number of collapsed bridges between 1970 and 1990 was 10. According to [1], this number further increased to 20 collapsed bridges between 1990 and 2010. In [2], Imam et al. collected and reviewed literature studies of metallic bridges to investigate bridge failure (the number of collapsed bridges over the years, the causes, the risks, etc.). In their study, the authors distinguished between bridges that have collapsed and those that have lost serviceability (not yet collapsed). They claimed that for bridges that have lost serviceability, fatigue failure was found to be the most predominant cause. It was found that welding was responsible for losing the serviceability of metallic bridges. Therefore, thorough and precise control of the post-weld treatment method used to extend the fatigue life of existing welded steel structures is essential.

Declaration of Competing Interest

The authors declare that they have no known competing financial interests or personal relationships that could have appeared to influence the work reported in this paper.

Acknowledgement

This work is a part of the research project “LifeExt” which is funded by Vinnova (project 2017-02670) and the Swedish Transport Administration (BBT 2017-018).

References

- [1] W. Cook, M. Asce, P.J. Barr, M. Asce, M.W. Halling, F. Asce, *Bridge Failure Rate* 29 (3) (2015) 1–8.
- [2] B. M. Imam and M. K. (2007) Chryssanthopoulos, A review of metallic bridge failure statistics.
- [3] A. Manai, Framework to assess and repair pre-fatigue weld steel structures by TIG dressing, *Engineering failure analysis* (2020), <https://doi.org/10.1016/j.engfailanal.2020.104923>.
- [4] A. Aeran, S.C. Siriwardane, O. Mikkelsen, I. Langen, (2017) A framework to assess structural integrity of ageing offshore jacket structures for life extension, *Marine Structures*, Vol. 56, pp.237-259, August.
- [5] S.S. Chaminda, M. Ogha, R. Dissanayake, K. Taniwaki, approaches for remaining fatigue life estimation of critical members in railway bridges, *International Journal of Steel Structures* (2007) 263–276.
- [6] D.J. Thomas, Analyzing the Failure of Welded Steel Components in Construction Systems, *J Fail. Anal. and Preven.* 18 (2018) 304–314.
- [7] D. Radaj, Review of fatigue strength assessment of nonwelded and welded structures based on local parameters, *Int J Fatigue* 18 (1996) 153–170.
- [8] G.B. Marquis, E. Mikkola, H.C. Yildirim, Z. Barsoum, Fatigue strength improvement of steel structures by high-frequency mechanical impact: proposed fatigue assessment guidelines, *Welding in the World* 57 (6) (2013) 803–822.
- [9] K. Ghahremani, M. Safa, J. Yeung, S. Walbridge, C. Haas, S. Dubois, Quality assurance for high-frequency mechanical impact (HFMI) treatment of welds using handheld 3d laser scanning technology, *Welding in the World* 59 (3) (2015) 391–400.
- [10] G. Le Quilliec, H.P. Lieurade, M. Bousseau, M. Drissi-Habti, G. Inglebert, P. Macquet, L. Jubin, Fatigue behavior of welded joints treated by high frequency hammer peening: Part i, experimental study. 64th Annual Assembly & International Conference of the International Institute of Welding, 2011.
- [11] V. Schulze, *Modern Mechanical Surface Treatment State Stability Effects*, first ed., WILEY-VCH Verlag GmbH & Co, KGaA, Weinheim, 2006.
- [12] ASM Committee on Shot Peening (ninth ed.) W.G. Wood (Ed.), *Metals Handbook, Surface Cleaning, Finishing and Coating*, vol. 5, American Society For Metals, Metals Park, Ohio (1994).
- [13] Martin U, Altenberger I, Scholtes B, Kremmer K, Oettel H. Cyclic deformation and near surface microstructures of normalized shot peened steel SAE 1045. *Mater. Sci.*
- [14] J.D. Almer, J.B. Cohen, B. Moran, The effects of residual macrostresses and microstresses on fatigue crack initiation, *Mater. Sci. Eng. A.* 284 (2000) 268–279.
- [15] A. Tange, in: ICSP4, Tokyo, 1990, pp. 337–345.
- [16] F. Klocke, S. Barth, P. Mattfeld, High Performance Grinding, *Procedia CIRP* 46 (2016) 266–271.
- [17] Y.-H. Zhang, Maddox, Fatigue life prediction for ground welded joints, *Int J Fatigue* 31 (2009) 1124–1134.
- [18] I. Lotsberg, A. Fjeldstad, M.R. Helsem, N. Oma, Fatigue life improvement of welded doubling plates by grinding and ultrasonic peening, *Welding in the World* 58 (6) (2014) 819–830.
- [19] BS 7608. Fatigue design and assessment of steel structures. British Standards Institution, London; 1993.
- [20] G.S. Booth, Improving the fatigue strength of welded joints by grinding – techniques and benefits, *Metal Constr* 18 (7) (1986) 432–437.
- [21] H.C. Yildirim, Review of fatigue data for welds improved by tungsten inert gas dressing, *International Journal of Fatigue* 79 (2015) 36–45.
- [22] T. Skriko, M. Ghafouri, T. Björk, Fatigue strength of TIG-dressed ultrahigh-strength steel fillet weld joints at high stress ratio, *International Journal of Fatigue* 94 (2017) 110–120.
- [23] L.C. Wu, D.P. Wang, Improve the fatigue performance of welded joints with undercuts by TIG dressing treatment, *Advanced Materials Research* 472 (2012) 1300–1304.
- [24] Manai A, Rüdiger Ulrich von Bock und Polach F, Al Emrani M., 2020, A probabilistic study of welding residual stresses distribution and their contribution to the fatigue life, *engineering failure analysis*. DOI: 10.1016/j.engfailanal.2020.104787.
- [25] C.M. Branco, S.J. Maddox, V. Infante, E.C. Gomes, Fatigue performance of TIG and plasma welds in thin section, *International journal of Fatigue* 22 (1999) 589–602.
- [26] L.L. Martinez, R. Lin, D. Wang, A.F. Blom, 1997, Investigation of residual stress in as welded and TIG-Dressed specimens subjected to statistic/spectrum loading, *Proceedings of north European Engineering and science conference (NESCO): Welding high- strength steel structures*, Stockholm-Sweden.
- [27] A. Manai, F. Von Bock, J. Hedegård Polach, A methodology for assessment and retrofitting by TIG dressing of existing pre-fatigued welded steel joints. 10th International conference on Bridge Maintenance, Safety and management, 2020.
- [28] P. Haagenen, S. Maddox, IIW recommendations on post weld improvement of steel and aluminium, *IIW Doc 13* (2003).
- [29] A.L. Ramalho, J.A. Ferreira, C.A. Branco, Fatigue behavior of T welded joints rehabilitated by tungsten inert gas and plasma dressing, *Materials & Design* 32 (10) (2011) 4705–4713.
- [30] J. W. Fisher, A. W. Pense, R. E. Slockbower, H. Hausammann, Retrofitting fatigue damaged bridges, *Transportation Research Record* (1978), no. 664.
- [31] C. Miki, T. Mori, S. Tuda, K. Sakamoto, Retrofitting fatigue-cracked joints by TIG arc remelting, *Doboku Gakkai Ronbunshu* no. 380 (1987) 111–119.
- [32] A. Manai, A literature review of pre-fatigued structures treated by TIG dressing, 10th International Conference on Bridge Maintenance, Safety and Management, IABMAS, Japan, 2020.

- [33] H. Al Karawi, A. Manai, J. Hedegård, Al Emrani M., Fatigue crack repair by TIG-remelting, IABMAS, Japan (2020).
- [34] Eurocodes, NF EN 1993-1-9 “ Calcul des structures en acier - Partie 1-9 : Fatigue”.
- [35] A. Hobbacher, et al., Recommendations for fatigue design of welded joints and components, Springer, 2009.
- [36] D.S. Forsyth, H.T. Yolken, G.A. Matzkanin, A brief introduction to non-destructive testing, AMMTIAC (2006;1(2):7e10.).
- [37] Y. Kawakam, H. Hidesada Kanaji, K. Oku, Study on application of field signature method (FSM) to fatigue crack monitoring on steel bridges, Procedia Eng 14: 1059e64 (2011).
- [38] P. Ferro, F. Berto, M.N. James, A simplified model for TIG-dressing numerical simulation, Modelling and Simulation in Material Science and Engineering. 25 035012 (2017).
- [39] P. Ferro, F. Bonollo, F. Berto, A. Montanari, Numerical modelling of residual stress redistribution induced by TIG-dressing, Frattura ed Integrità Strutturale 47 (2019) 221–230.
- [40] Haagensen, P.J. Drågen, A. Slind, T. Ørjasæter, O. (1987). Prediction of the improvement in fatigue life of welded joints due to grinding, TIG dressing, weld shape control and shot peening, ECSC Offshore Conference on Steel in Marine Structures.